

DIY2401 A-dress with puff sleeve #pernilledress

Seam allowance is included on all patterns:
 Sleeve hem 6 cm
 All other seams 1 cm



You need to cut the following parts

Part 1	Front	x1
Part 2	Back	x1
Part 3	Sleeve	x2
Part 4	Facing front	x1
Part 5	Facing back	x1
Part 6	Ruffle	x2 full fabric width x 20 cm
Part 7	Button loop	x1

You need the following fabric and accessories

UK Size	6-12	14-18
EU Size	34-40	42-46

Fabric:	w/145 cm	265	275
Interlining:	w/90 cm	25	25

Accessories:
 1 Button + elastic 5 mm cut 2 x 31 cm

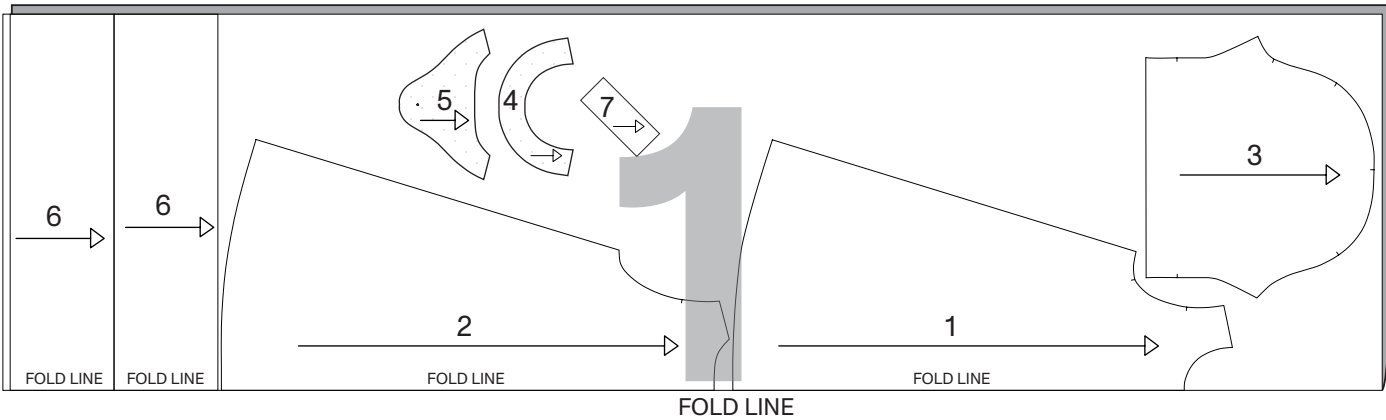

Symbols you may find on your patterns

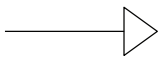

Grain line

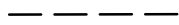

Fold line

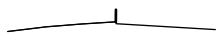

Notch



Gathering

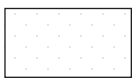

Interlining



Cut line

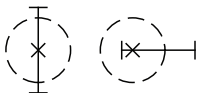

Placement of button and buttonhole

10 CM

Self
made®

CONTROL SQUARE:

Print page 1, to check the square measurements:

If the measurements do not match, please adjust your printer settings.

10 CM

CONTROL PAGE FIT:

In print preview check page margin. Margin have to be equal on all 4 sides of each page.

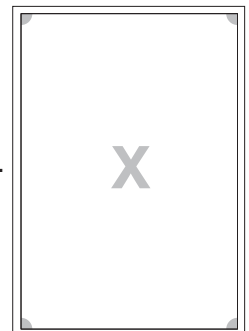

Glue or tape your patterns together as shown in the diagram

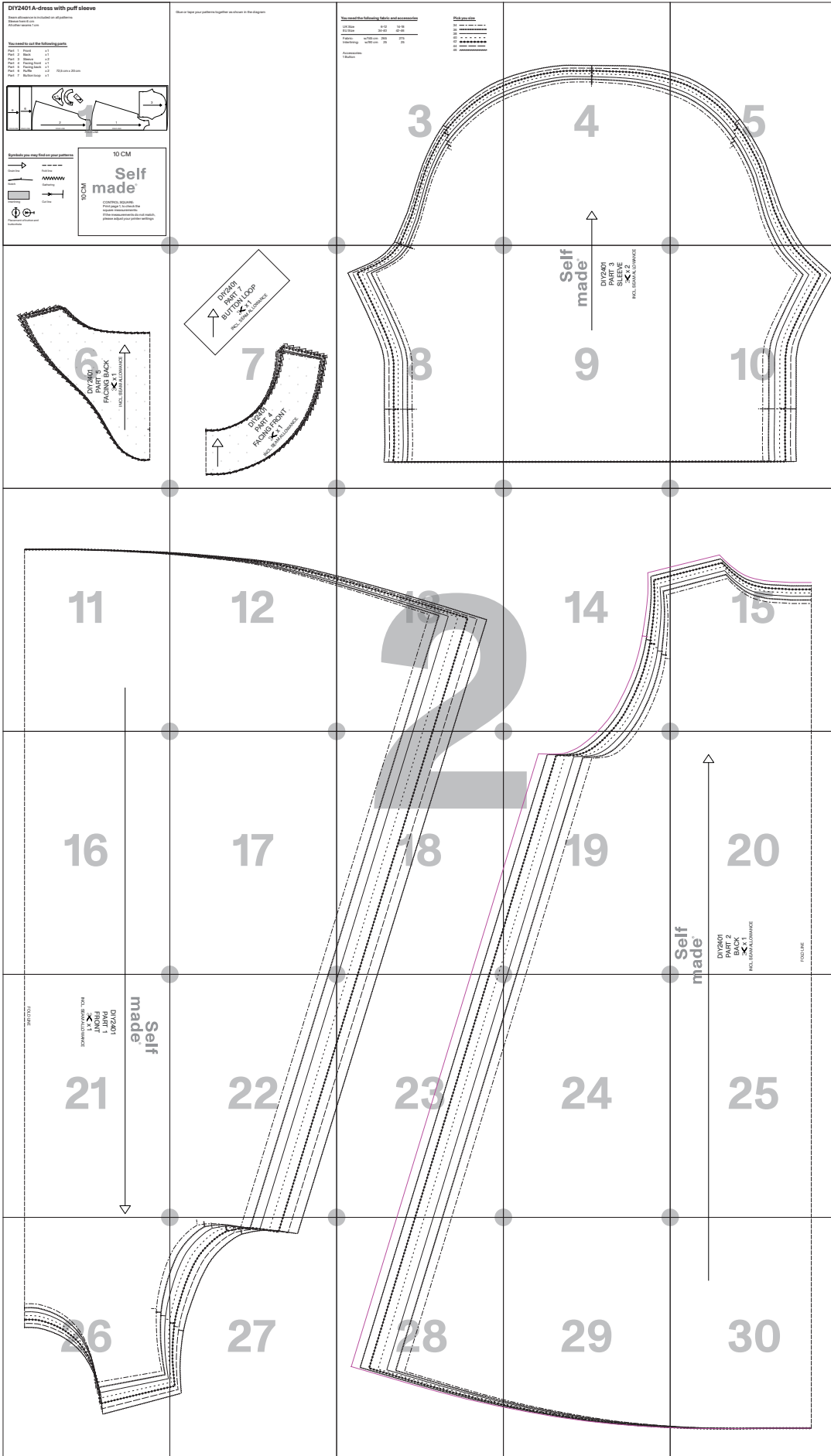

Pick you size

- 34 - - - - -
- 36 ·····
- 38 ———
- 40 - - - - -
- 42 ●●●●●●
- 44 ———
- 46 ~~~~~

3

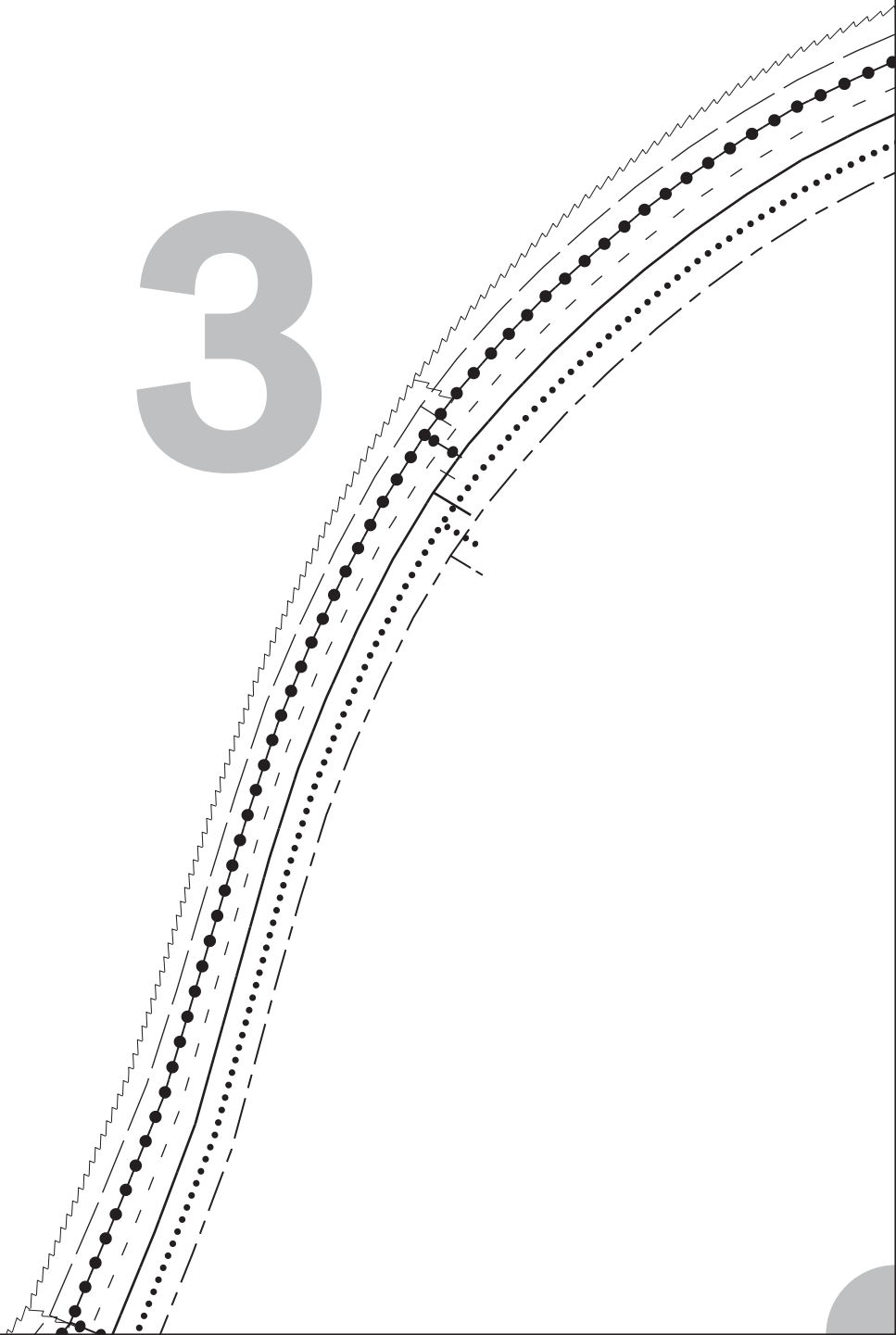

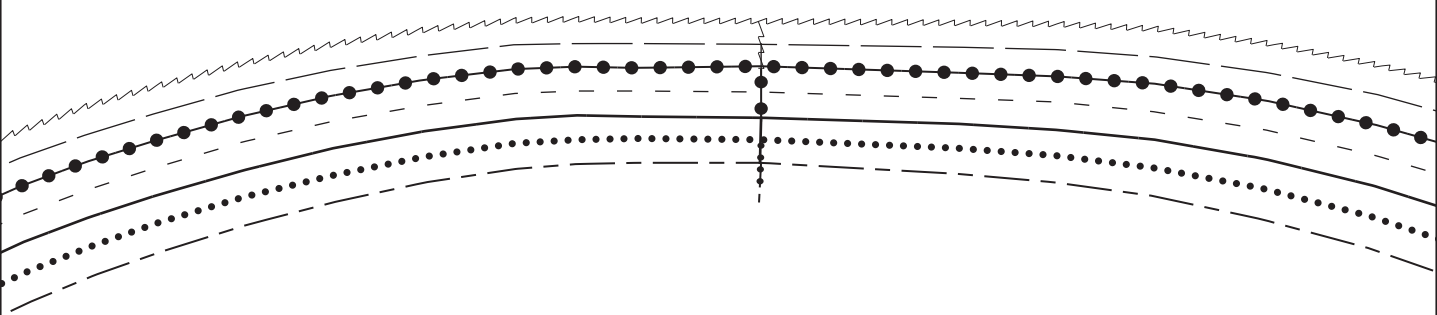

4

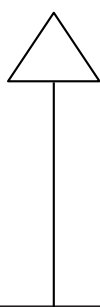

5

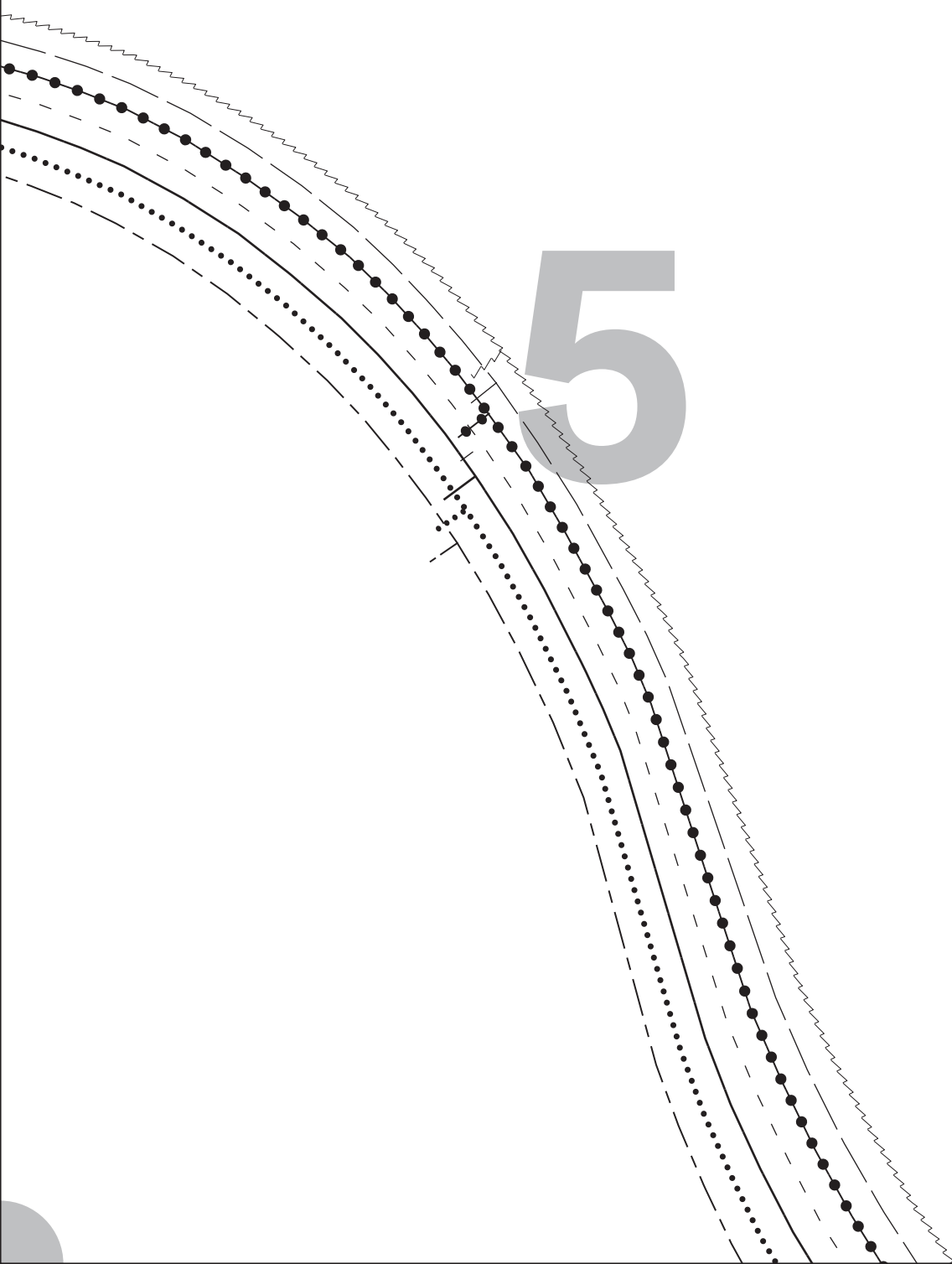

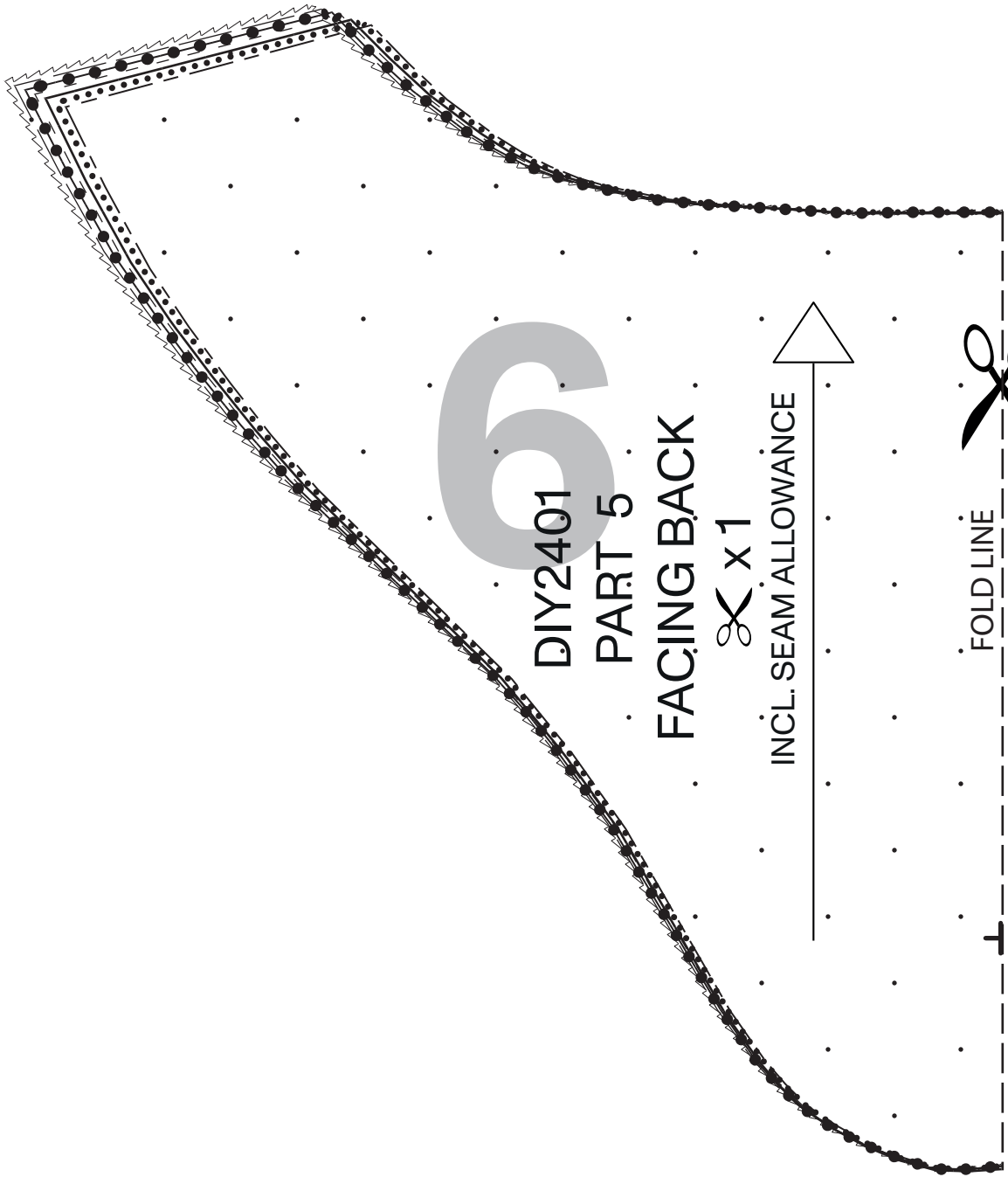

DIY2401

PART 5

FACING BACK

✂ x1

INCL. SEAM ALLOWANCE

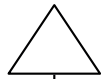

FOLD LINE



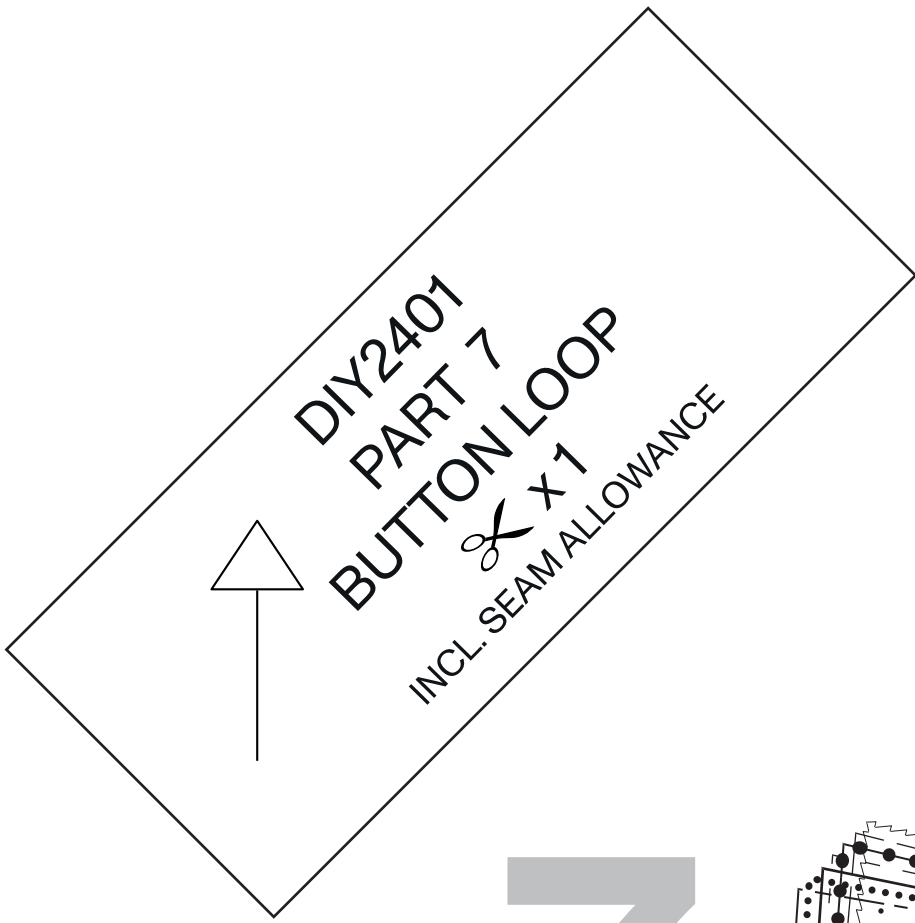

7

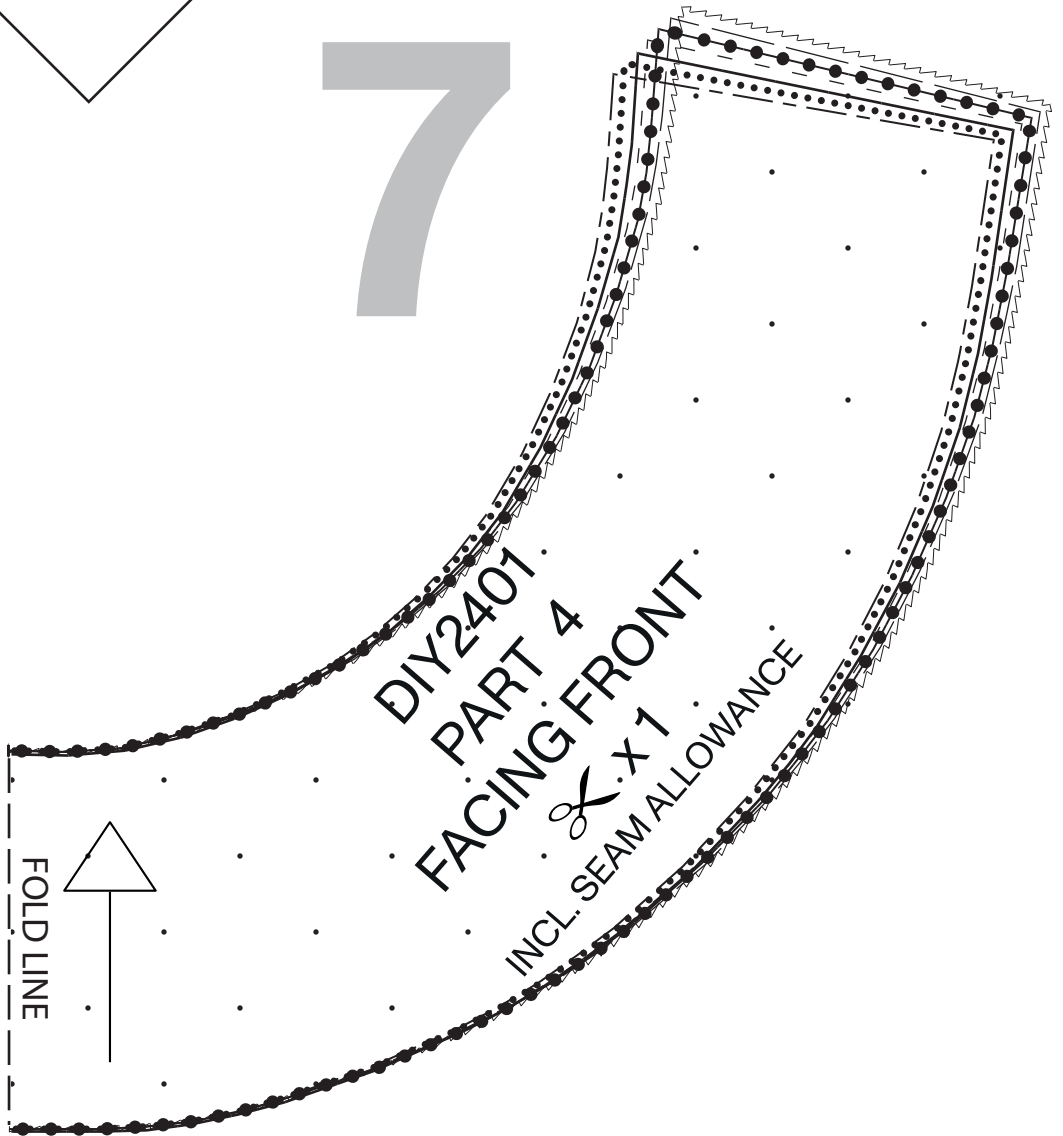

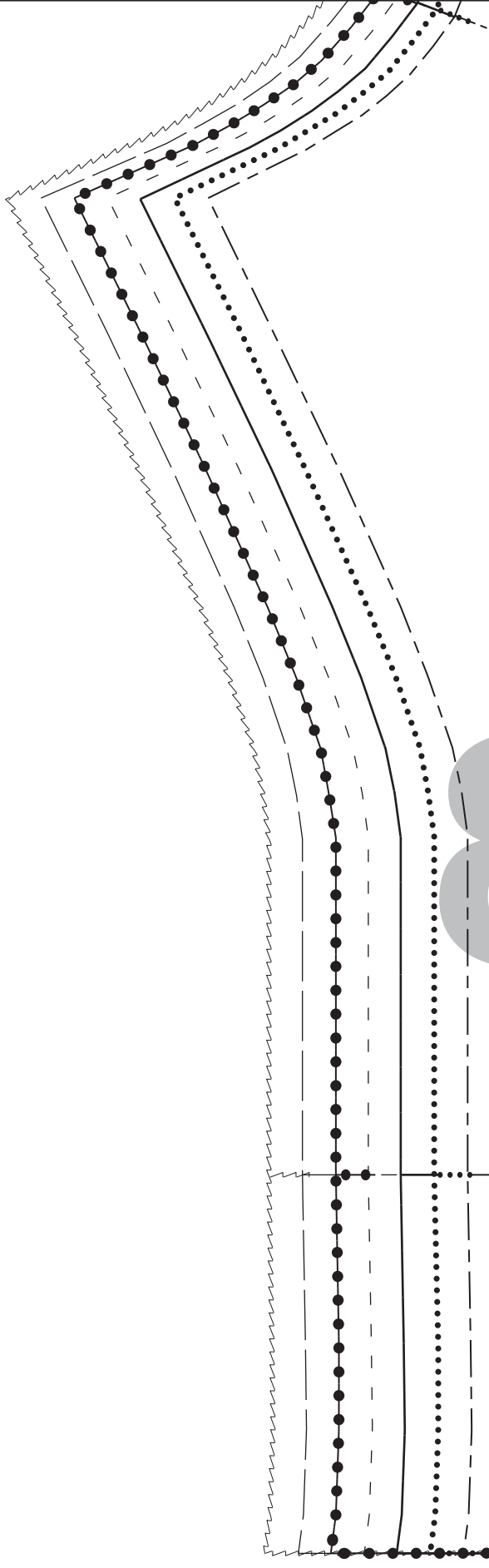

8



9

Self
made[®]

DIY2401
PART 3
SLEEVE
✂ x 2

INCL. SEAM ALLOWANCE

10

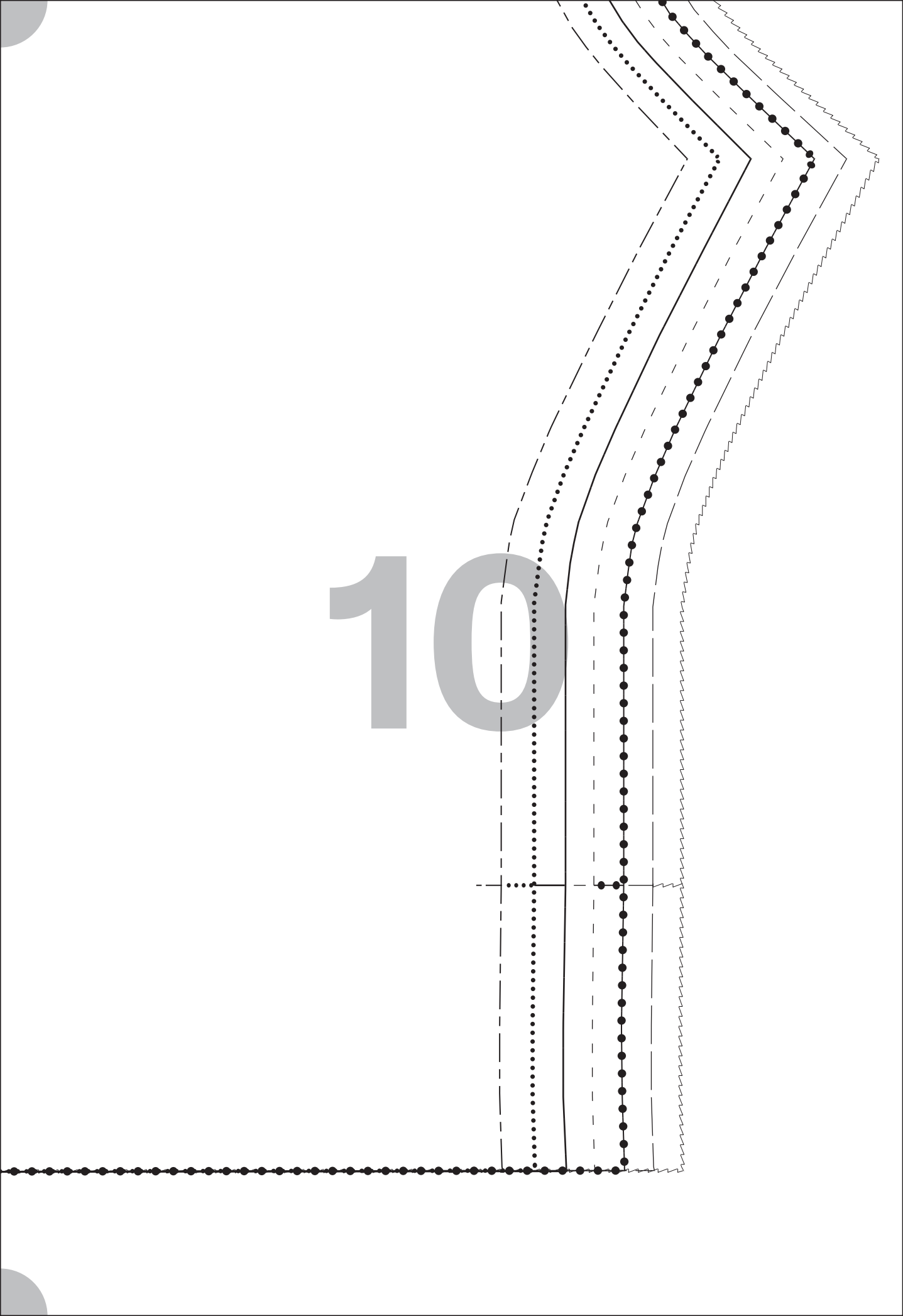



11

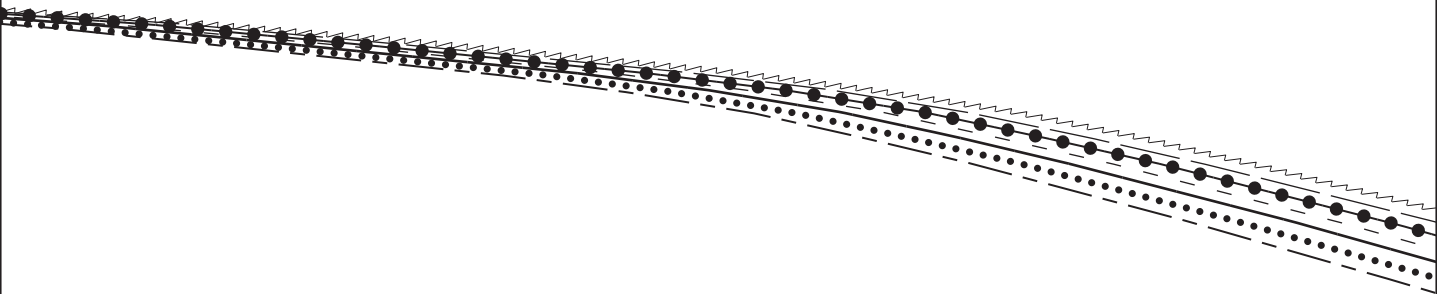

12

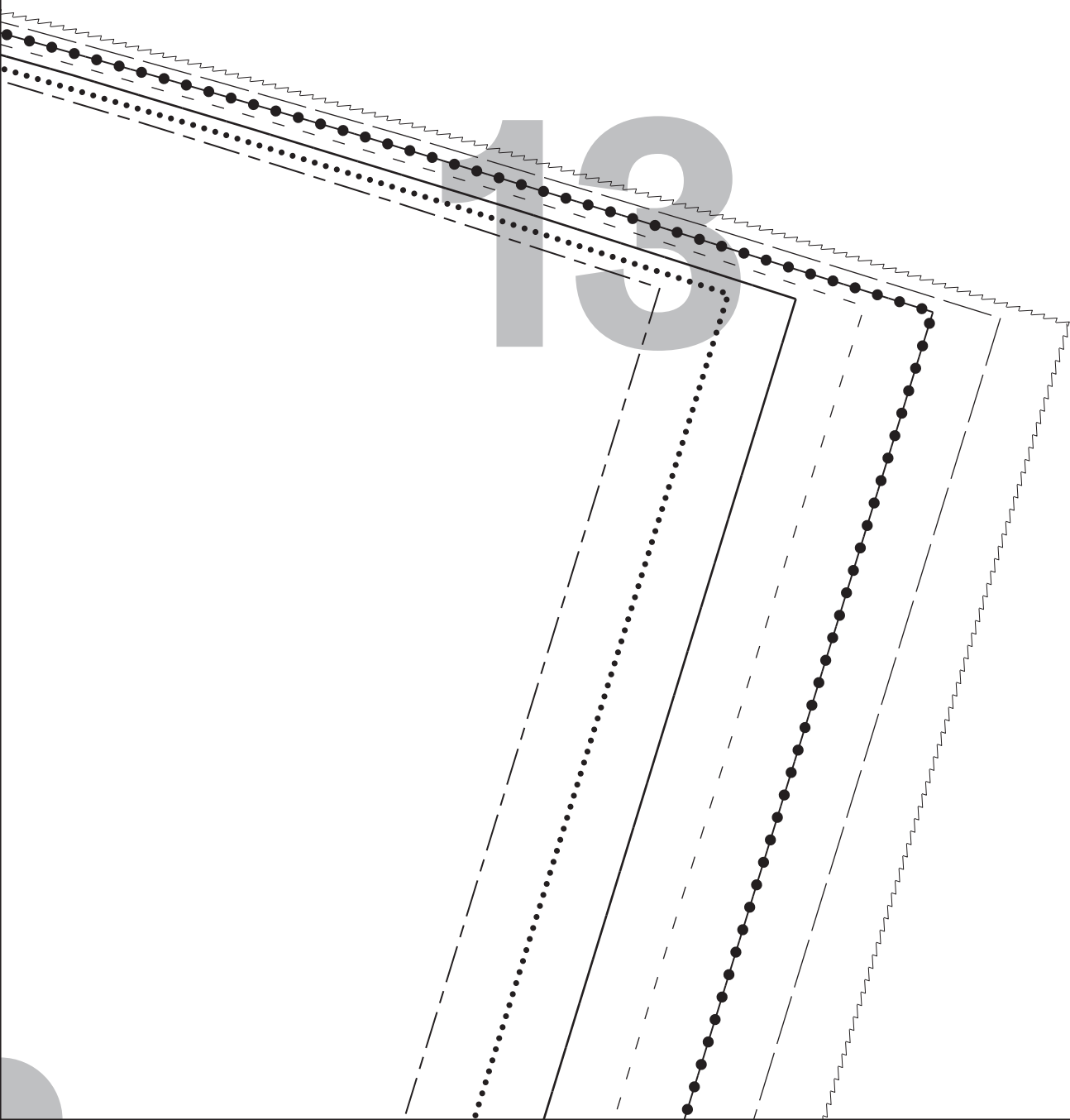

14



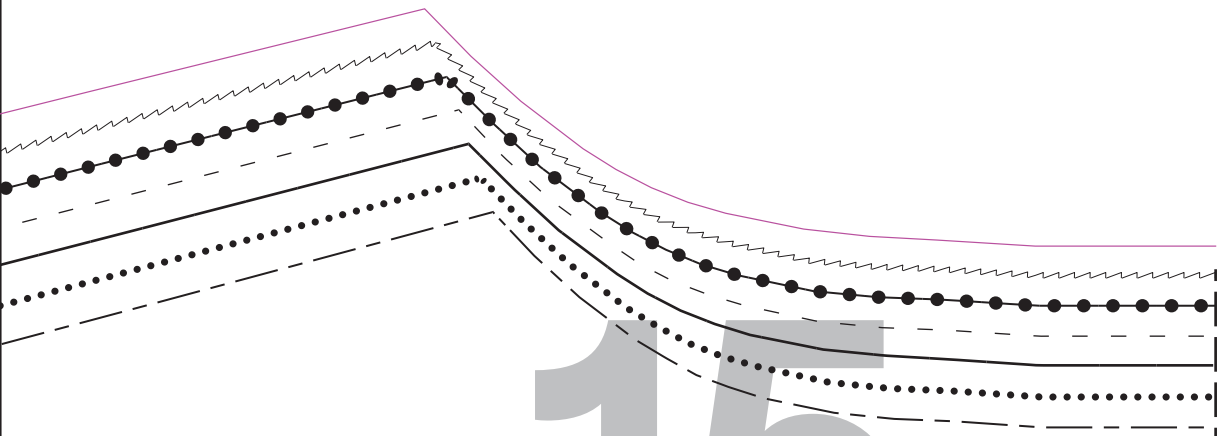

15

16

17

18

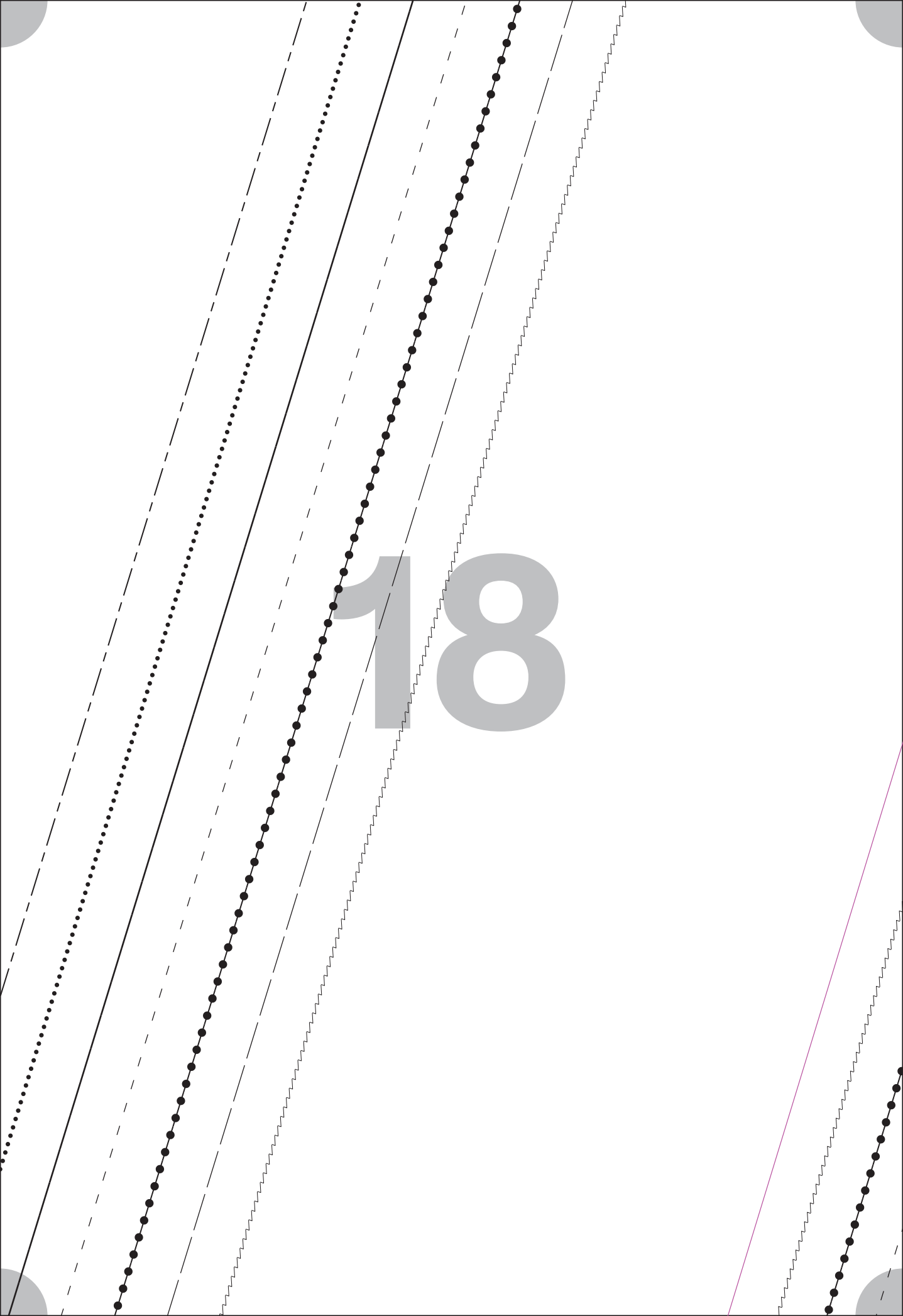

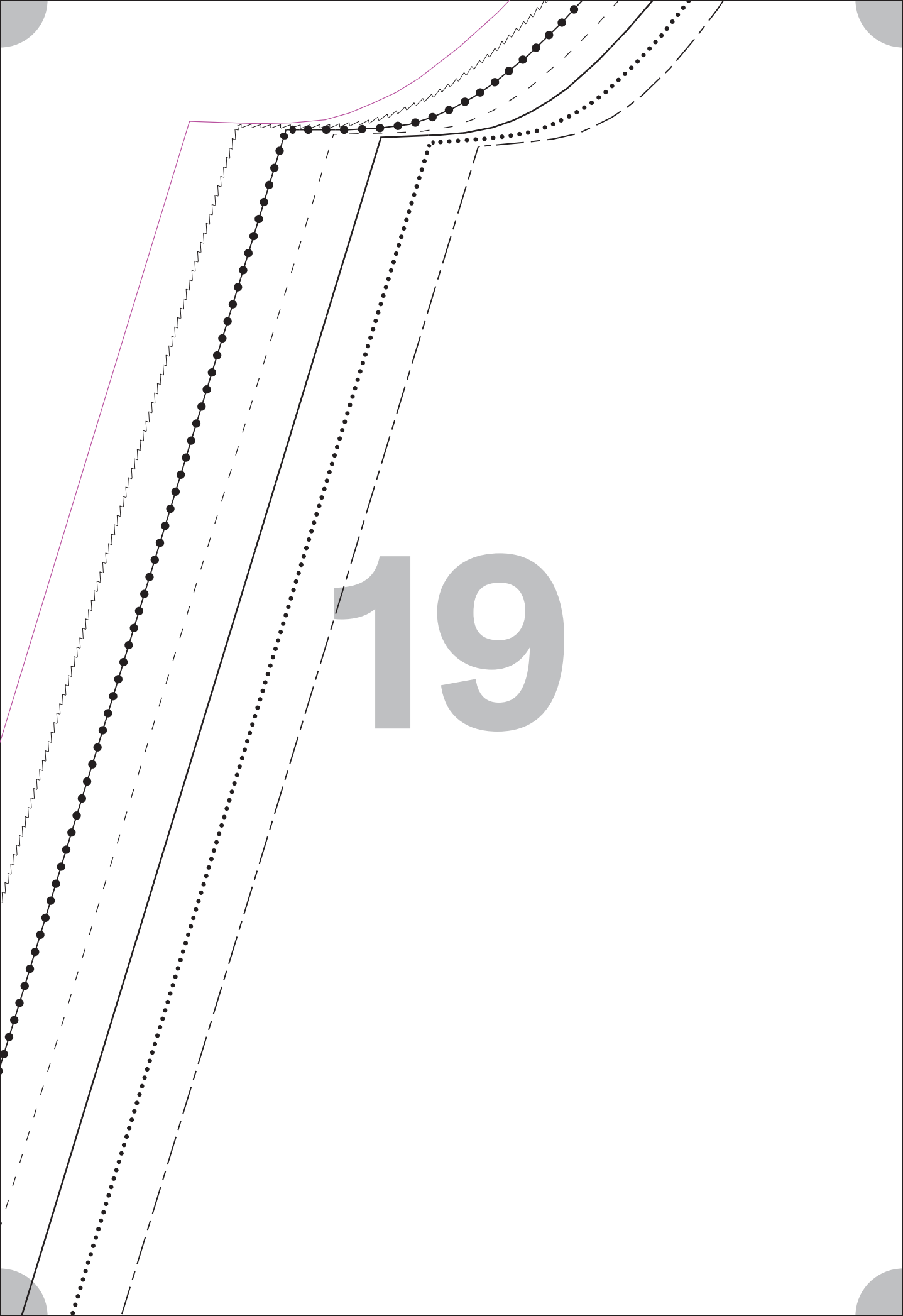

19

**Self
made®**

DIY2401

PART 2

BACK



x1

INCL. SEAM ALLOWANCE

20

FOLD LINE

Self made®

DIY2401

PART 1

FRONT



x 1

INCL. SEAM ALLOWANCE

21

FOLD LINE



22

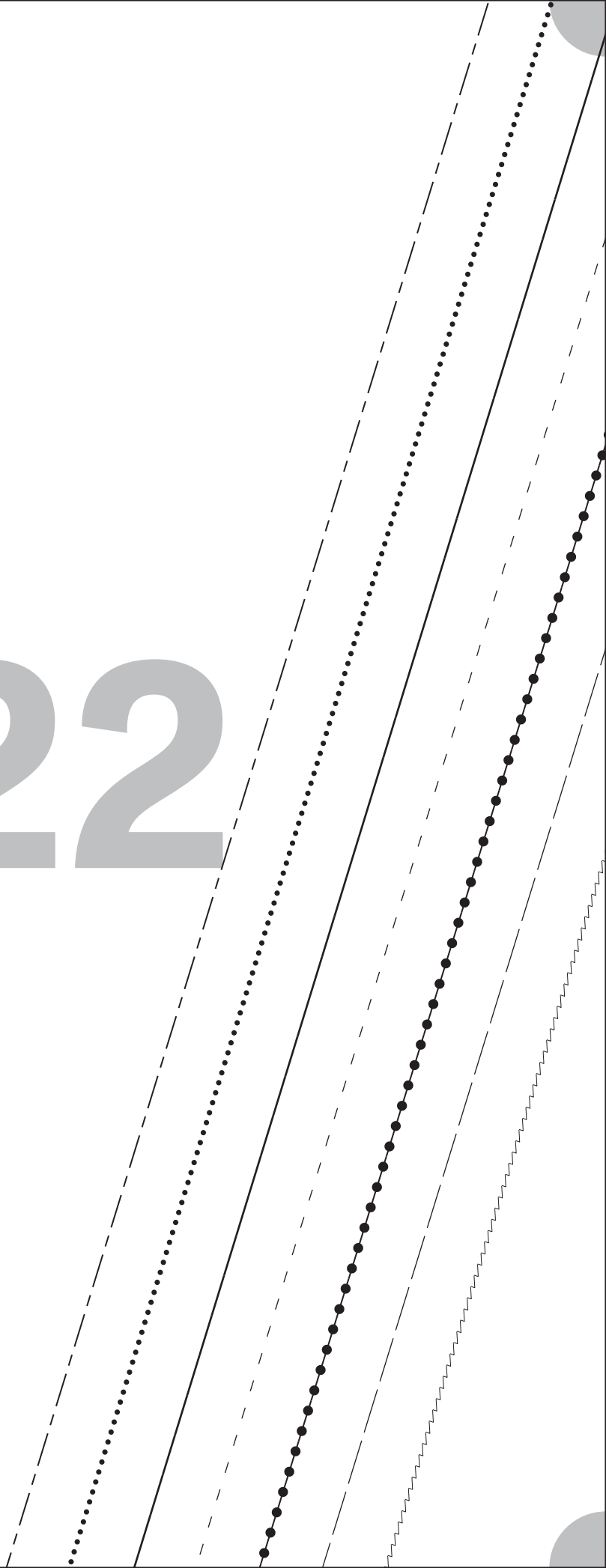

23

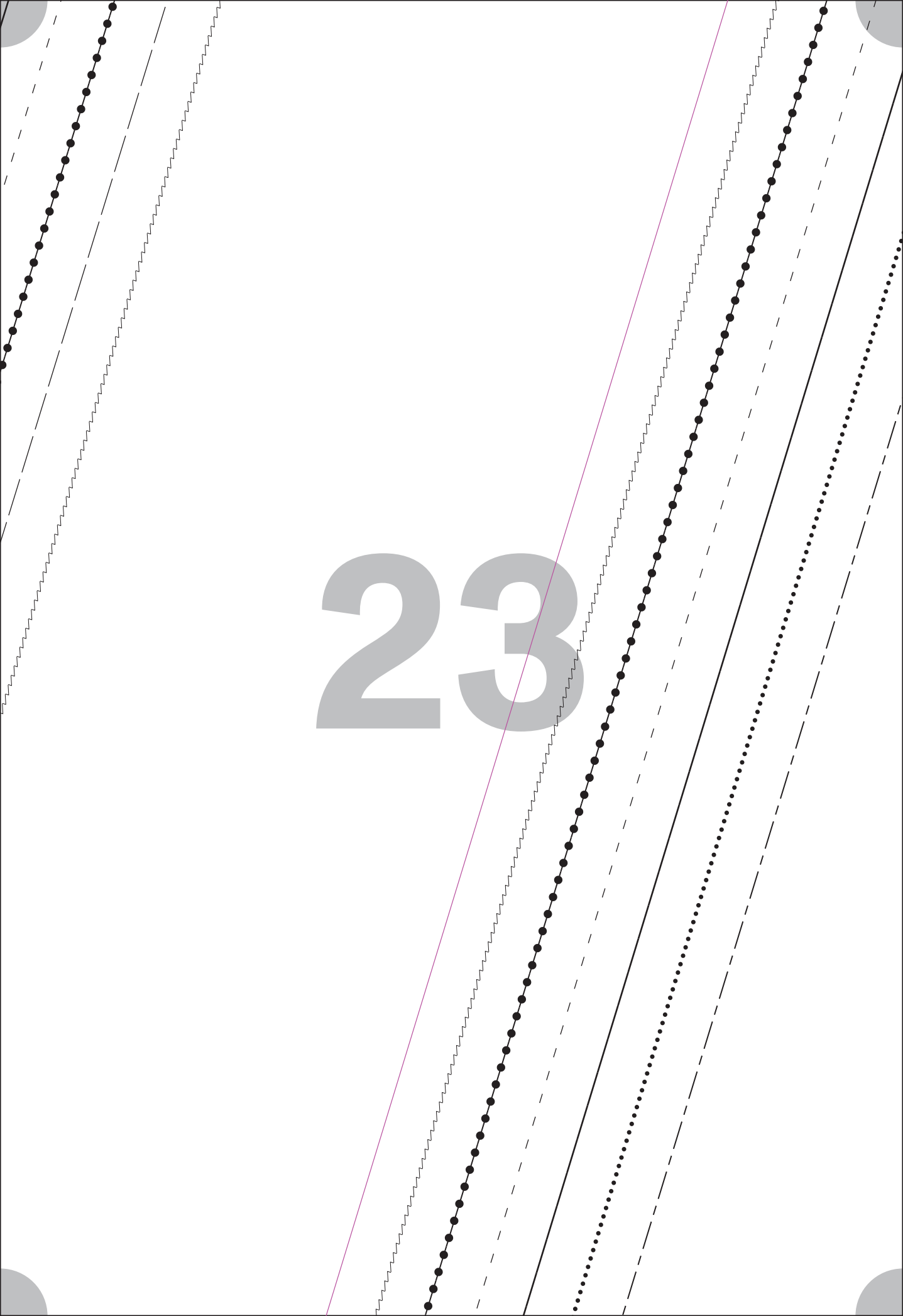



24



m

25

26

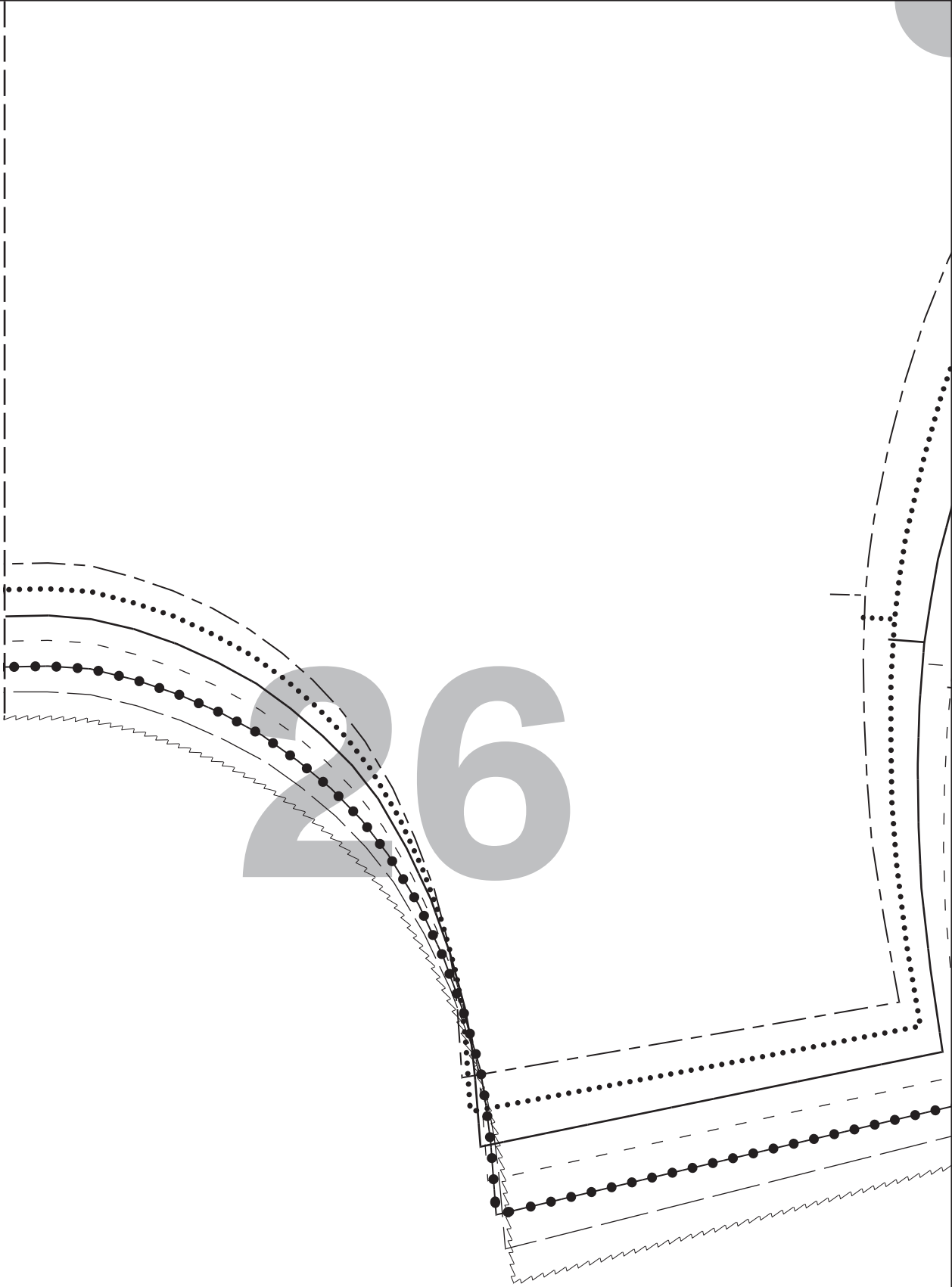

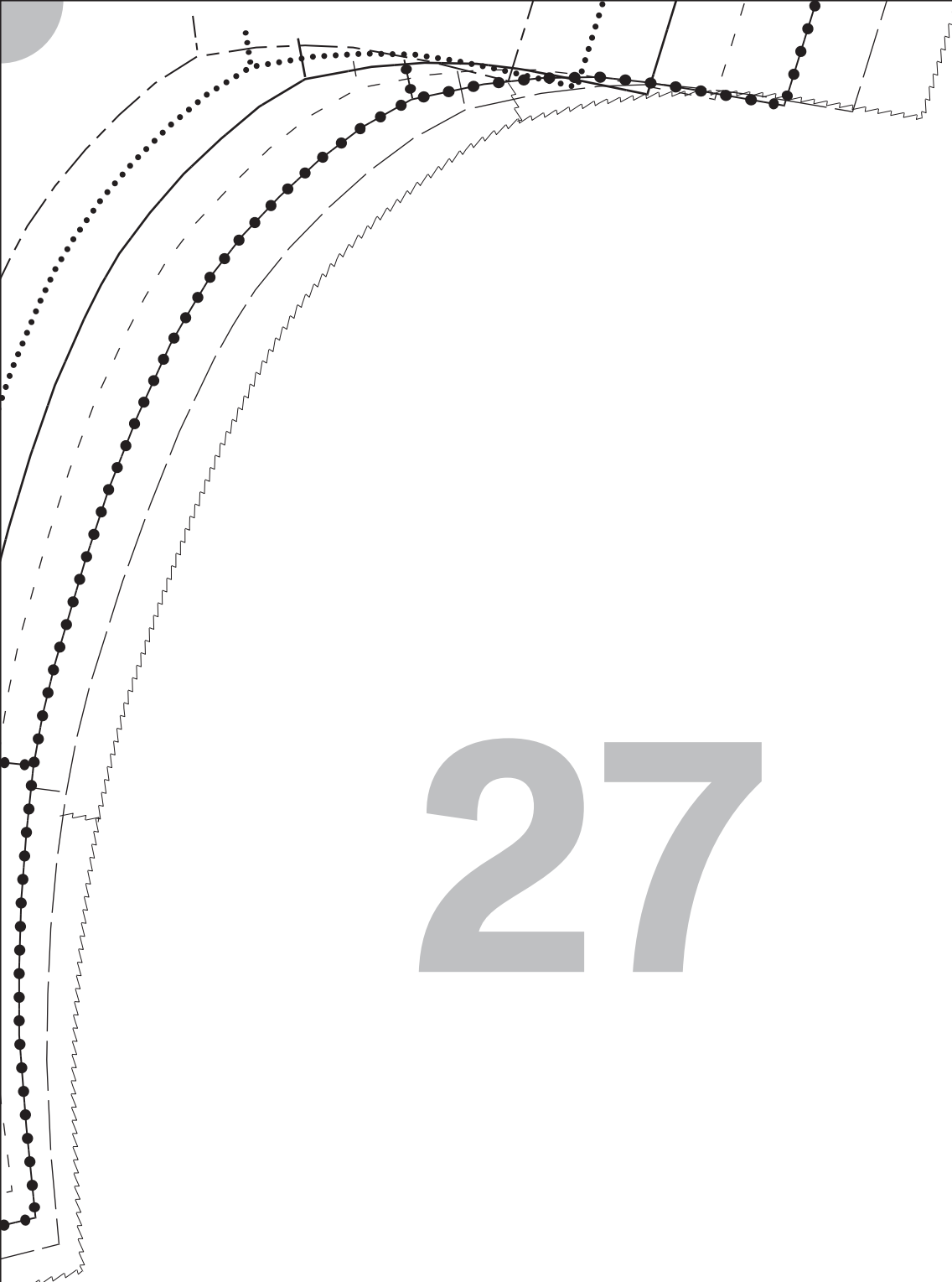

27

28

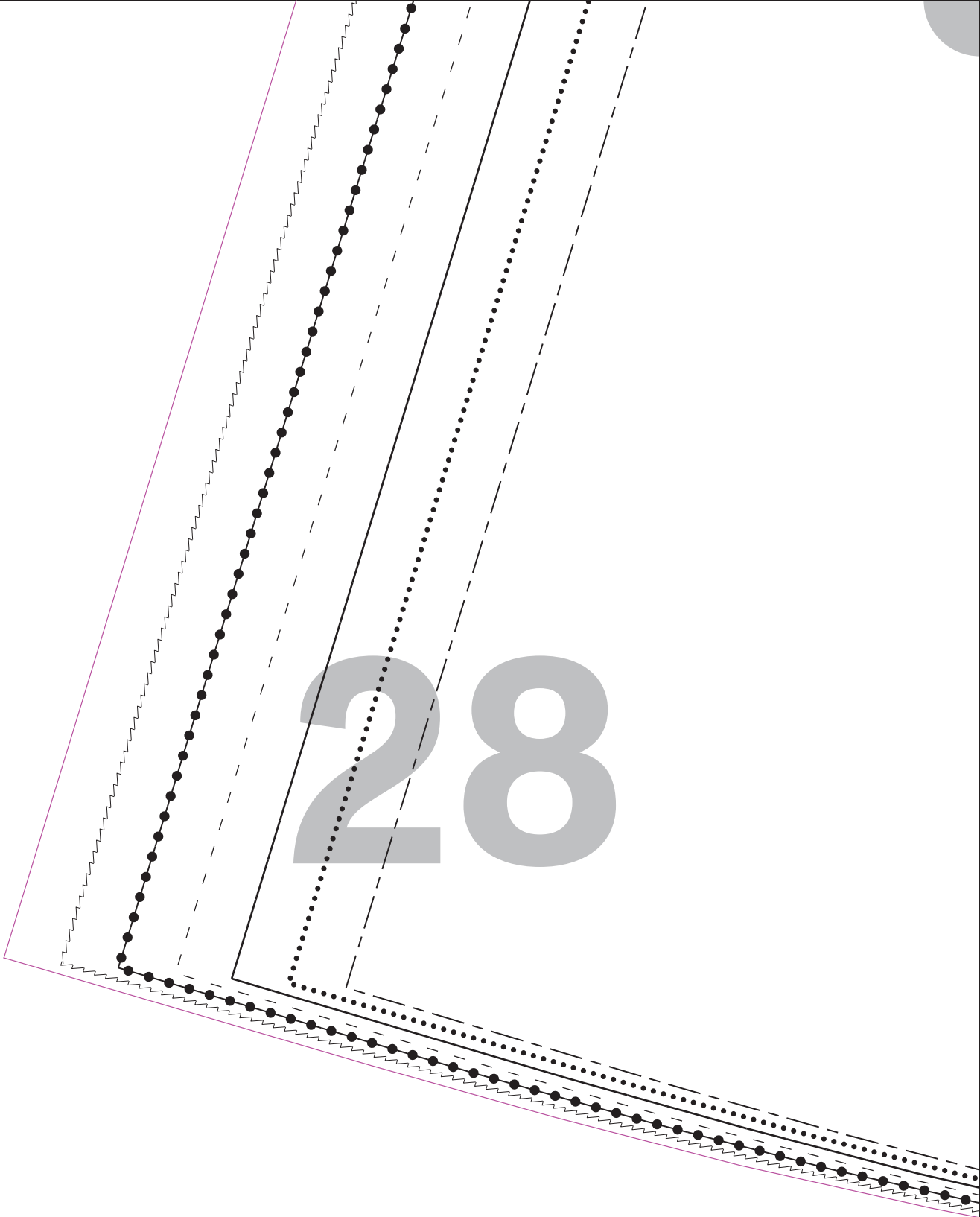

29

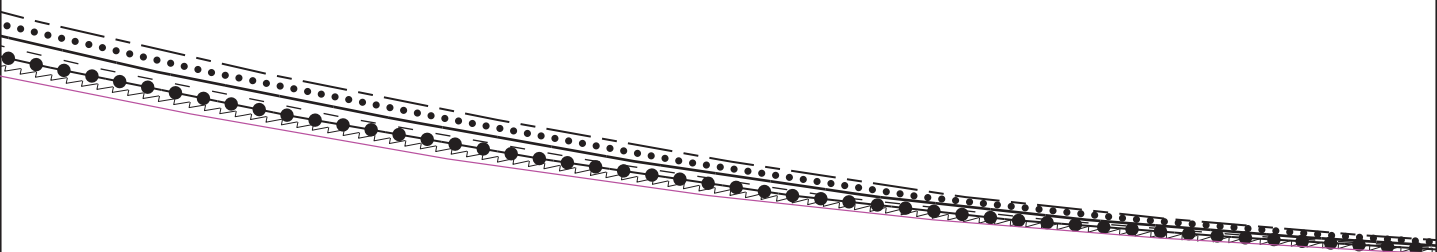

30